

# We are IntechOpen, the world's leading publisher of Open Access books Built by scientists, for scientists

4,400

Open access books available

117,000

International authors and editors

130M

Downloads

Our authors are among the

154

Countries delivered to

TOP 1%

most cited scientists

12.2%

Contributors from top 500 universities



WEB OF SCIENCE™

Selection of our books indexed in the Book Citation Index  
in Web of Science™ Core Collection (BKCI)

Interested in publishing with us?  
Contact [book.department@intechopen.com](mailto:book.department@intechopen.com)

Numbers displayed above are based on latest data collected.  
For more information visit [www.intechopen.com](http://www.intechopen.com)



---

# Optoelectronic Oscillators Phase Noise and Stability Measurements

---

Patrice Salzenstein

Additional information is available at the end of the chapter

<http://dx.doi.org/10.5772/3463>

---

## 1. Introduction

A classical method to characterize the spectral density of phase noise of microwave oscillators is to compare the device under test (DUT) to another one, we call it the reference, with the same frequency if noise is expected to be better for the reference. In most of case it is possible to then characterize oscillators or synthesizers. But it is only possible if we can assign the same frequency to the DUT and the reference signal. However for some applications, we see that the DUT delivers a frequency hard to predict during the fabrication. We here focus on characterizing a special class of oscillators, called optoelectronic oscillators (OEO) [1]. An OEO is generally an oscillator based on an optical delay line and delivering a microwave signal [2]. Purity of microwave signal is achieved thanks to a delay line inserted into the loop. For example, a 4 km delay corresponds to a 20  $\mu$ s-long storage of the optical energy in the line. The continuous optical energy coming from a laser is converted to the microwave signal. This kind of oscillators were investigated [3]. By the way, such OEO based on delay line are still sensitive to the temperature due to the use of optical fiber. Recently, progress were made to set compact OEO thanks to optical mini-resonators or spheres [4 - 7]. Replacing the optical delay line with an ultra-high Q whispering gallery-mode optical resonator allows for a more compact setup and an easier temperature stabilization. In order to introduce into the loop the fabricated resonator in  $\text{MgF}_2$  [8],  $\text{CaF}_2$  or fused silica, it has to be coupled to the optical light coming from a fiber. Best way to couple is certainly to use a cut optical fiber through a prism. But a good reproducible way in a laboratory is to use a tapered fiber glued on a holder. Then appears a problem for determining the phase noise of such compact OEO, because the frequency is rarely predictable. It is impossible to choose the frequency of the modulation (for instance exactly 10 GHz) and that's why it is necessary to develop new instruments and systems to determine phase noise for any delivered signal

in X-band (8.2-12.4 GHz) for instance. Here we come to our goal. The aim of this chapter is to provide a tool for a better knowledge of the phase noise characterization of OEO's using an optoelectronic phase noise system. We logically start by giving the main principle of how work such a system. We see that the main idea is to use delay lines to perform phase noise measurements. We also considerably increase the performances of such a system by cross correlation measurement, thanks to the two quasi-identical arms developed instrument. Then we present a realized system and the evaluation of its uncertainty based on international standard for determination of uncertainties when characterizing an OEO in X-band.

## 2. Principle of the phase noise measurement system

A quasi-perfect RF-microwave sinusoidal signal can be written as :

$$v(t) = V_0 [1 + \alpha(t)] \cos(2\pi\nu_0 t + \varphi(t)) \quad (1)$$

where  $V_0$  is the amplitude,  $\nu_0$  is the frequency,  $\alpha(t)$  is the fractional amplitude fluctuation, and  $\varphi(t)$  is the phase fluctuation. Equation (1) defines  $\alpha(t)$  and  $\varphi(t)$  in low noise conditions:  $|\alpha(t)| \ll 1$  and  $|\varphi(t)| \ll 1$ . Short-term instabilities of signal are usually characterized in terms of the single sideband noise spectral density PSD  $S(f)$ . Phase noise  $\mathcal{L}(f)$  is typically expressed in units of dBc/Hz, representing the noise power relative to the carrier contained in a 1 Hz bandwidth centered at a certain offsets from the carrier. So,  $S$  is typically expressed in units of decibels below the carrier per hertz (dBc/Hz) and is defined as the ratio between the one-side-band noise power in 1 Hz bandwidth and the carrier power:

$$\mathcal{L}(f) = \frac{1}{2} \cdot S\varphi(f) \quad (2)$$

This definition given in equation (2) includes the effect of both amplitude and phase fluctuations. Phase noise is the frequency domain representation of rapid, short-term, random fluctuations in the phase of a waveform, caused by time domain instabilities. However we must know the amplitude and phase noise separately because they act differently in the circuit. For example, the effect of amplitude noise can be reduced by amplitude limiting mechanism and mainly suppressed by using a saturated amplifier. Phase noise of microwave oscillators can usually be characterized by heterodyne measurement. Whereas, for such a system, we need a reference oscillator operating exactly at the frequency of the DUT with lower phase noise. Phase noise can be measured using a spectrum analyzer if the phase noise of the device under test (DUT) is large with respect to the spectrum analyzer's local oscillator. Care should be taken that observed values are due to the measured signal and not the Shape Factor of the spectrum analyzer's filters. Spectrum analyzer based measurement can show the phase-noise power over many decades of frequency. The slope with offset frequency in various offset frequency regions can provide clues as to the source of the noise, e.g. low frequency flicker noise decreasing at 30 dB per decade.

Reference is no more required for homodyne measurement with a delay line discriminator. At microwave frequencies, electrical delay is not suitable because of its high losses. However photonic delay line offers high delay and low attenuation equal to 0.2 dB/km at the wavelength  $\lambda=1.55 \mu\text{m}$ . Optoelectronic phase noise measurement system is schematically represented on Figure 1.

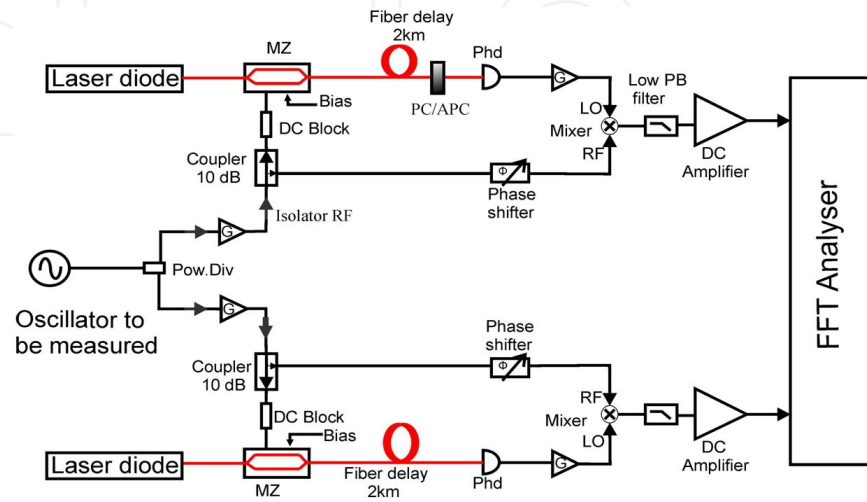

**Figure 1.** Phase noise bench.

It consists on two equal and fully independent channels. The phase noise of the oscillator is determined by comparing phase of the transmitted signal to a delayed replica through optical delay using a mixer. It converts the phase fluctuations into voltage fluctuations. An electro-optic modulator allows modulation of the optical carrier at microwave frequency. The length of the short branch where microwave signal is propagating is negligible compared to the optical delay line. Mixers are used as phase detectors with both saturate inputs in order to reduce the amplitude noise contribution. The low pass filters are used to eliminate high frequency contribution of the mixer output signal. DC amplifiers are low flicker noise.

The oscillator frequency fluctuation is converted to phase frequency fluctuation through the delay line. If the mixer voltage gain coefficient is  $K_\varphi$  (volts/radian), then mixer output rms voltage can be expressed as :

$$V_{out}^2(f) = K_\varphi^2 |H_\varphi(jf)|^2 S_\varphi(f) \quad (3)$$

Where  $|H_\varphi(jf)|^2 = 4.\sin^2(\pi f\tau)$  is the transfer function of optical delay line, and  $f$  is the offset frequency from the microwave carrier. Equation (3) shows that the sensitivity of the bench depends directly on  $K_\varphi^2$  and  $|H_\varphi(jf)|$ . The first is related to the mixer and the second essentially depends on the delay  $\tau$ . In practice, we need an FFT analyzer to measure the spectral density of noise amplitude  $V_{out}^2(f)/B$ , where  $B$  is the bandwidth used to calculate  $V_{out}(f)/B$ . The phase noise of the DUT is finally defined by Eq. (4) and taking into account the gain of DC amplifier  $G_{DC}$  as :

$$\mathcal{L}(f) = [V_{out}^2(f)] \cdot / \cdot [2K_{\varphi}^2 \cdot |H_{\varphi}(jf)|^2 G_{DC} \cdot B] \quad (4)$$

Such instruments has been recently introduced [3,9,10]. In section 3, we present concretely a realized optoelectronic phase noise measurement system.

### 3. Description of the realized system

In this section we concretely present a realization. We apply the principle detailed in the previous section to settle a phase noise optoelectronic system. For the demonstration, we characterize a frequency synthesizer as a DUT. It presents advantage to check different frequencies in X-band. System is shown on Figure 2.

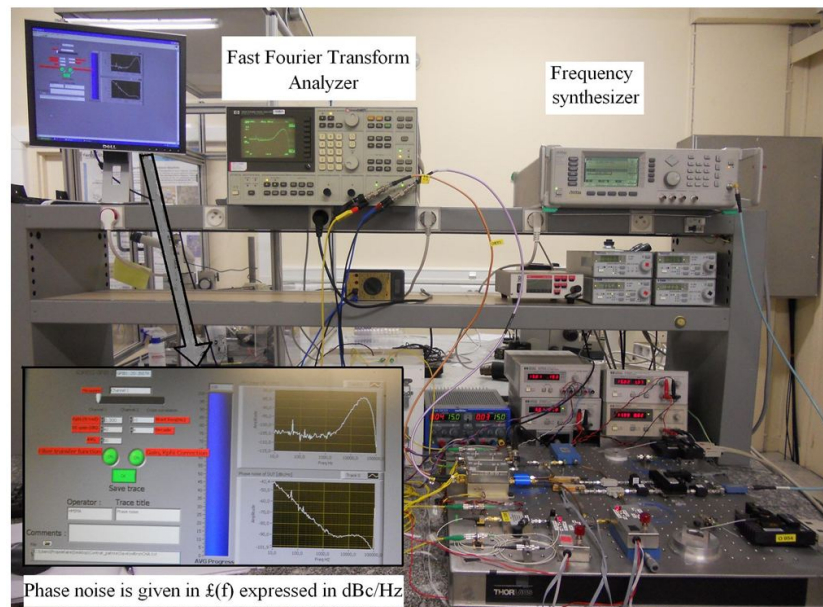

**Figure 2.** Picture of the phase noise measurement system.

The system is composed from different parts. We see on Figure 2, that we use a frequency synthesizer to check if the system works properly in X-band. On the picture we see the results of the phase noise characterization (inserted on the left of the picture) for a +3 dBm, 10 GHz signal. On the top of the picture we see the double channels Fast Fourier Transform analyzer used for this purpose (*Hewlett-Packard* HP3561A).  $\mathcal{L}(f)$  expressed in dBc/Hz is deduced from the data provided by the FFT analyzer are given in  $V^2/Hz$ .

Figure 3 shows the picture of the *Hewlett-Packard* HP3561A FFT analyzer. Note that the data are expressed in  $V^2/Hz$ . It is necessary to use a program to get the expected quantity  $\mathcal{L}(f)$  in dBc/Hz. It is developed in the next section of this chapter.

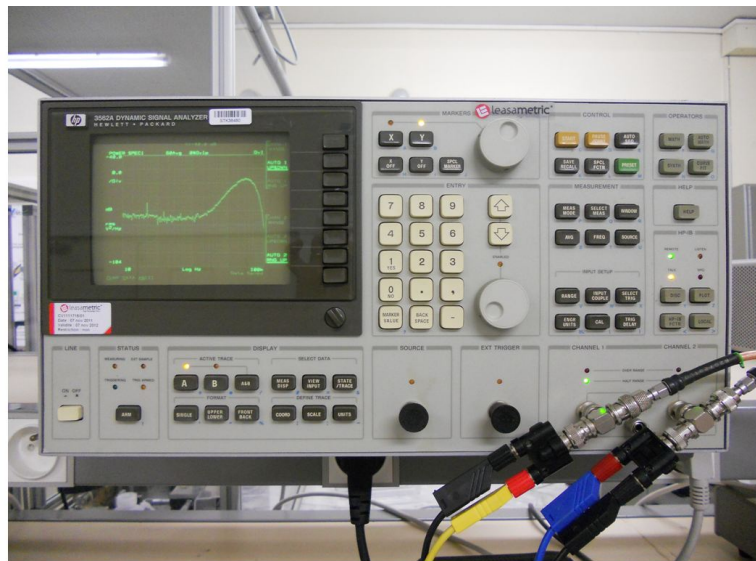

**Figure 3.** Picture of the double channels *Hewlett-Packard* HP3561A FFT analyzer.

#### 4. Validation of the performances

The measured phase noise includes the DUT noise and the instrument background. The cross correlation method allows to decrease the cross spectrum terms of uncommon phase noise as  $\sqrt{(1/m)}$ , where  $m$  is the average number. Thereby uncorrelated noise is removed and sensitivity of measure is improved. To validate the measure of our phase noise bench, we need to compare data sheet of the commercial frequency synthesizer Anritsu/Wiltron 69000B [11] with the phase noise we measure using our system.

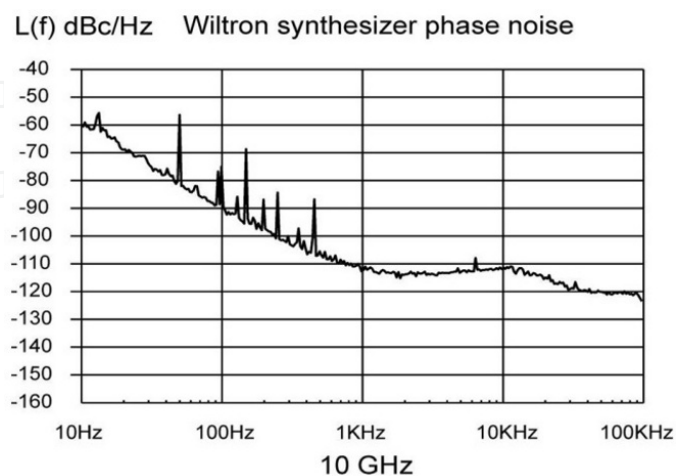

**Figure 4.** Phase noise (dBc/Hz) of the synthesizer measured at 10 GHz with  $K_{\phi}=425$  mV/rad and  $G_{DC}=40$  dB versus Fourier Frequency between 10 Hz and 100 kHz.

Figure 4 shows the result of this measure. We can see that our bandwidth is limited to 100 kHz ( $\tau = 10 \mu\text{s}$ ) and the measured phase noise corresponds to the data sheet.

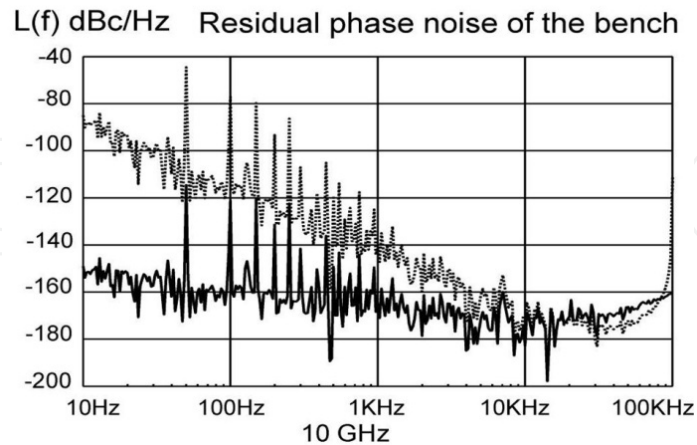

**Figure 5.** Phase noise floor (dBc/Hz) of the bench measured at 10 GHz with Anritsu synthesizer (500 averages) versus Fourier Frequency between 10 Hz and 100 kHz.

Figure 5 represents the background phase noise of the bench after performing 500 averaged with cross-correlation method, when removing the 2 km optical delay line. In this case, phase noise of the 10 GHz synthesizer is rejected. The solid curve shows noise floor (without optical transfer function) respectively better than -150 and -170 dBc/Hz at  $10^1$  and  $10^4$  Hz from the 10 GHz carrier. Dotted curve is the noise floor when optical fiber is introduced.

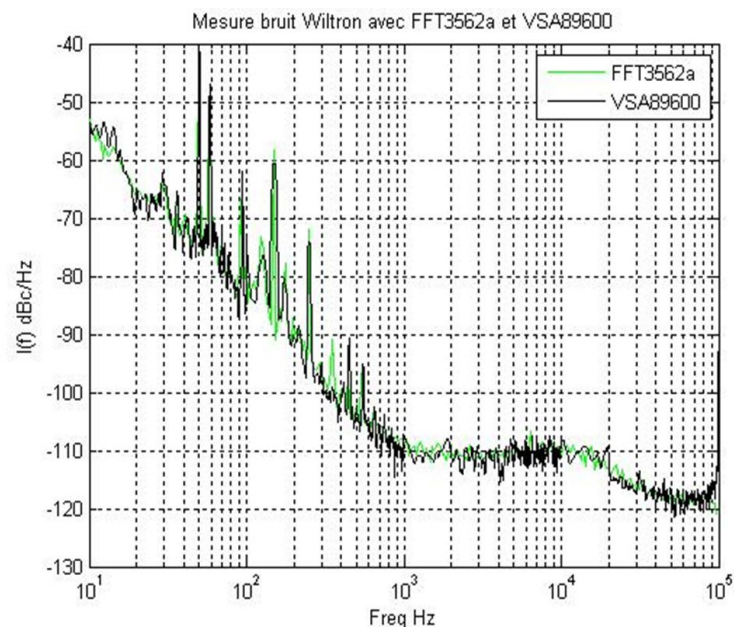

**Figure 6.** Spectral density of phase noise floor  $L(f)$  expressed in dBc/Hz versus Fourier frequencies (in Hz) between 10 Hz and 100 kHz for a commercial synthesizer measured with our bench with  $K_\phi = 425 \text{ mV/rad}$  and  $\text{GDC} = 40 \text{ dB}$  for two different FFT analyzing system : *Hewlett-Packard 3562A* and *Agilent 89600*.

One can note that the use of a shorter delay line in a optoelectronic phase noise measurement system working in X-band, allow a characterization of the phase noise far from the carrier. Fourier frequency analysis can be extended from  $10^5$  to  $2 \times 10^6$  Hz by introducing a 100 m delay line in addition of a 2 km optical fiber [12]. As the Fast Fourier Transform (FFT) analyzer (*Hewlett-Packard* 3562A) used for characterizing the noise up to 100 kHz from the carrier is not operating for higher frequencies, it is necessary to use another FFT such as an *Agilent* 89600 for instance.

On Figure 6, we check that the two different FFT systems provide the same results for Fourier frequencies between 10 Hz and 100 kHz.

Note that our results are as expected with the data sheet of a 10 GHz phase noise spectrum for an *Wiltron* 69000B series. Our bandwidth is limited to 100 kHz ( $\tau = 10 \mu\text{s}$ ) and the measured phase noise corresponds to the data sheet. Figure 6 then gives the noise floor of the instrument versus Fourier frequencies. The noise floor is respectively better than  $-90$  and  $-170$  dBc/Hz at  $10^3$  and  $5 \times 10^6$  Hz from the carrier.

The introduction of a 100 m short fiber in addition to the 2 km fiber allows to characterize phase noise of oscillators with an optoelectronic phase noise measurement system.

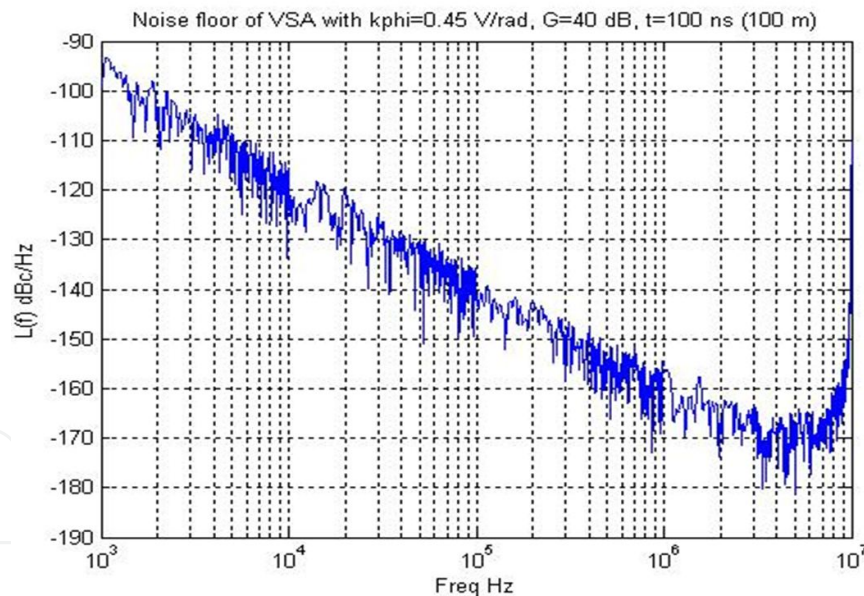

**Figure 7.** Spectral density of phase noise floor  $L(f)$  expressed in dBc/Hz versus Fourier frequencies (in Hz) for the developed system when using the 100 meters delay lines.

100 m fiber corresponds to a 500 ns delay. So the  $10^5$  Hz limit due to the 2 km fiber can be extended from  $10^5$  to  $2 \times 10^6$  Hz from the carrier. This system works for any microwave signal in X-band (8.2 – 12.4 GHz) especially for those delivered by optoelectronic oscillators. We see on Figure 7 that the noise floor of the system is in the range of  $-165$  dBc/Hz at  $5 \cdot 10^6$  Hz from the X-band microwave signal.

## 5. Evaluation of the uncertainty of such a measurement system

This evaluation is based on a previous work [13]. For the evaluation of the uncertainty, we use the main guideline delivered by the institution in charge of international metrology rules, *Bureau International des Poids et Mesures* (BIPM) in the guide "Evaluation of measurement data – Guide to the expression of uncertainty in measurement" [14]. According to this guideline, the uncertainty in the result of a measurement generally consists of several components which may be grouped into two categories according to the way in which their numerical value is estimated. The first category is called "type A". It is evaluated by statistical methods such as reproducibility, repeatability, special consideration about Fast Fourier Transform analysis, and the experimental standard deviation. The components in category A are characterized by the estimated variances. Second family of uncertainties contributions is for those which are evaluated by other mean. They are called "type B" and due to various components and temperature control. Experience with or general knowledge of the behavior and properties of relevant materials and instruments, manufacturer's specifications, data provided in calibration and other certificates (noted BR), uncertainties assigned to reference data taken from handbooks. The components in category B should be characterized by quantities which may be considered as approximations to the corresponding variances, the existence of which is assumed.

### 5.1. "Type A". Statistical contributions

Uncertainty on  $\mathcal{L}(f)$  strongly depends on propagation of uncertainties through the transfer function as deduced from equation (3). We see here that "type A" is the main contribution. For statistical contributions aspects, the global uncertainty is strongly related to repeatability of the measurements. Repeatability (noted A1) is the variation in measurements obtained by one person on the same item and under the same conditions. Repeatability conditions include: the same measurement procedure, the same observer, the same measuring instrument, used under the same conditions, repetition over a short period of time, the same location. We switch on all the components of the instrument and perform a measurement keeping the data of the curve. Then we need to switch them off and switch them on again to obtain another curve. We must repeat this action several times until we have ten curves. Elementary term of uncertainty for repeatability is experimentally found to be equal to 0.68 dB.

Other elementary terms of statistical contributions still have lower contributions.

Reproducibility, noted A2, is the variability of the measurement system caused by differences in operator behavior. Mathematically, it is the variability of the average values obtained by several operators while measuring the same item. The variability of the individual operators are the same, but because each operator has a different bias, the total variability of the measurement system is higher when three operators are used than when one operator is used. When the instrument is connected, there is no change of each component or device inside. That makes this term negligible because, for example, the amplifier is never replaced by another one. We remark that, if one or more of the components would be replaced, it will be necessary to evaluate the influence of the new component on the results of measure-

ments. Main aspect is that operators are the same. In our case, operator don't change. It means a first approximation we can take 0 dB for this uncertainty.

Uncertainty term due to the number of samples is noted A3. It depend on how many points are chosen for each decades. For this term, we check how works the Fast Fourier Transform (FFT) analyzer, it leads to an elementary term of uncertainty less than 0.1 dB.

Finally, statistical contribution can be considered as:

$$A = \sqrt{(\sum A_i^2)} \quad (5)$$

According to equation (5), it can then be considered that the whole statistical contribution is better than 0.69 dB.

## 5.2. "Type B". Other means

Our system is not yet formally traceable to any standard, according to how the phase noise is determined. Phase noise measurement generally don't need to be referenced to a standard as the method is intrinsic. So the data provided in calibration and other certificates, noted BR, are not applicable. It results that we can take 0 dB as a good approximation of BR.

Influence of the gain of the DC amplifier, noted BL1, is determined to be less than 0.04 dB.

Temperature effects, noted BL2, are less than 0.1 dB as optical fiber regulation system of temperature in turned on.

Resolution of instruments, noted BL3, is determined by the value read on each voltmeter when we need to search minimum and maximum for the modulator but also for wattmeter. Resolution is then no worse than 0.1 dB.

During the measurement, what influence could bring the DUT, generally an oscillator to be characterized? We call BL4 the influence of the variation of the DUT. It stays negligible while the variation stay limited. It results that we can keep 0 dB as a reasonable value for BL4 if the DUT is not too unstable.

Uncertainty on the determination of the coefficient  $K_\varphi$  (noted BL5) dependent for the slope expressed in Volt/rad is found to be lower than 0.08dB.

For the contribution of the use of automatic/manual range, noted BL6, we can deduce from experimental curves that this influence is no more than 0.02 dB. In our case, all these terms were found lower than repeatability.

The influence of the chosen input power value of the DUT, noted BL7, is negligible as the input power in normal range i. e. between -4 dBm and +6 dBm, has a very limited influence. We experimentally observe an influence. It stay better than 0.02 dB.

Other elementary terms still have lower contributions. BL is the arithmetic sum of each elementary contribution. It is determine to be 0.38 dB.

### 5.3. Estimation of the global uncertainty of this system

According to the Guide to the expression of uncertainty in measurement, uncertainty at 1 sigma interval of confidence is calculated as follows:

$$u_c = \sqrt{(A^2 + BR^2 + BL^2)} \quad (6)$$

We deduce from equation (6) that uncertainty at 1 sigma, noted  $u_c$ , is better than 0.79 dB.

Table 1 summarizes how is deduced the global uncertainty for the spectral density of phase noise at 1 sigma.

Uncertainty	Designation	Value (in dB)
A1	Repeatability	0.68
A2	Reproductibility	0
A3	Uncertainty term due to the number of sample	0.1
A	$(\sum A_i^2)^{1/2}$	0.69
BR	Not applicable	0
BL1	Gain of the DC amplifier	0.04
BL2	Influence of the temperature	0.1
BL3	Influence of the resolution of the instrument	0.1
BL4	Influence of the power of the DUT	0
BL5	Uncertainty on the determination of $K_\phi$	0.08
BL6	Contribution of automatic/manual range	0.02
BL7	Influence of the variation of the input power	0.02
BL	$\sum BL_i$	0.38
$u_c$	Global uncertainty at 1 sigma: $(A^2 + BR^2 + BL^2)^{1/2}$	0.79

**Table 1.** Budget of uncertainties.

Its leads to a global uncertainty of  $U = 2xu_c = 1.58$  dB at 2 sigma.

For convenience and to have an operational uncertainty in case of degradation or drift of any elementary term of uncertainty, it is wise to degrade the global uncertainty. That's why we choose to keep  $U = 2$  dB at 2 sigma for a common use of the optoelectronic system for phase noise determination. According to this evaluation of the uncertainty at 1 sigma, it leads to 1.58 at two sigma. It concretely means that it is possible to determine the phase noise of a single oscillator in X-band with a global uncertainty set to be better than  $\pm 2$  dB.

## 6. Conclusion

The author wish that the phase noise optoelectronic system presented in this chapter is useful for those who want to understand how the phase noise can be experimentally determined. We detailed performances and consideration about estimation of the uncertainty to show the main advantage of such developed instrument for metrology or telecommunication applications and characterizations of compact OEO's operating in X-band. With high performance better than -170 dBc/Hz at 10 kHz from the 10 GHz carrier, it is interesting to underline that it is possible to determine the phase noise of a single oscillator in X-band with a global uncertainty set to be better than  $\pm 2$  dB. This system is to be extended at lower and higher microwave operating frequencies.

## Acknowledgements

Author would like to thank his colleagues from FEMTO-ST, Besançon, Ms. Nathalie Cholley, Engineer, Dr. Abdelhamid Hmima and Dr. Yanne K. Chembo, CNRS senior researcher, for fruitful discussions. Author also acknowledges the French National Research Agency (ANR) grant "ANR 2010 BLAN 0312 02".

## Author details

Patrice Salzenstein\*

Address all correspondence to: patrice.salzenstein@femto-st.fr

Centre National de la Recherche Scientifique (CNRS), Unité Mixte de Recherche (UMR), Franche Comté Electronique Mécanique Thermique Optique Sciences et Technologies (FEMTO-ST), France

## References

- [1] Salzenstein, P. (2011). Optoelectronic Oscillators. In: Sergiyenko O. (ed.) Optoelectronic Devices and Properties. Rijeka: InTech;. Available from <http://www.intechopen.com/books/optoelectronic-devices-and-properties/optoelectronic-oscillators> (accessed 5 June 2012)., 401-410.
- [2] Yao, X. S., & Maleki, L. (1994). High frequency optical subcarrier generator. *Electronics Letters*, 30(18), 1525-1526.
- [3] Volyanskiy, K., Cussey, J., Tavernier, H., Salzenstein, P., Sauvage, G., Larger, L., & Rubiola, E. (2008). Applications of the optical fiber to the generation and to the meas-

- urement of low-phase-noise microwave signals. *Journal of the Optical Society of America B*, 25(12), 2140-2150.
- [4] Ilchenko, V. S., Yao, X. S., & Maleki, L. (1999). High-Q microsphere cavity for laser stabilization and optoelectronic microwave oscillator. *Proceedings of SPIE*, 3611-190.
- [5] Volyanskiy, K., Salzenstein, P., Tavernier, H., Pogurmirskiy, M., Chembo, Y. K., & Larger, L. (2010). Compact Optoelectronic Microwave Oscillators using Ultra-High Q Whispering Gallery Mode Disk-Resonators and Phase Modulation. *Optics Express* ., 18(21), 22358-22363.
- [6] Schliesser, A., & Kippenberg, T. J. (2010). Cavity Optomechanics with Whispering-Gallery Mode Optical Micro-Resonators. *Acta Avances in Atomic Molecular and Optical Physica*, 58-207.
- [7] Salzenstein, P., Tavernier, H., Volyanskiy, K., Kim, N. N. T., Larger, L., & Rubiola, E. (2009). Optical Mini-disk resonator integrated into a compact optoelectronic oscillator. *Acta Physica Polonica A*, 116(4), 661-663.
- [8] Tavernier, H., Salzenstein, P., Volyanskiy, K., Chembo, Y. K., & Larger, L. (2010). Magnesium Fluoride Whispering Gallery Mode Disk-Resonators for Microwave Photonics Applications. *IEEE Photonics Technology Letters*, 22(22), 1629-1631.
- [9] Salzenstein, P., Cussey, J., Jouvenceau, X., Tavernier, H., Larger, L., Rubiola, E., & Sauvage, G. (2008). Realization of a Phase Noise Measurement Bench Using Cross Correlation and Double Optical Delay Line. *Acta Physica Polonica A*, 112(5), 1107-1111.
- [10] Salzenstein, P., Cholley, N., Zarubin, M., Pavlyuchenko, E., Hmima, A., Chembo, Y. K., & Larger, L. (2011). Optoelectronic phase noise system designed for microwaves photonics sources measurements in metrology application. *Proceedings of SPIE* ., 8071-807111.
- [11] Anritsu (2000). Typical datasheet Anritsu 69B serie available on page at the following link: [http://cem.inrets.fr/private/materiel-labo/images/m\\_011\\_doc\\_gene\\_65ghz.pdf](http://cem.inrets.fr/private/materiel-labo/images/m_011_doc_gene_65ghz.pdf) (accessed 5 June 2012)., 8.
- [12] Salzenstein, P., Hmima, A., Zarubin, M., Pavlyuchenko, E., & Cholley, N. (2012). Optoelectronic phase noise measurement system with wideband analysis. *Proceedings of SPIE*, 8439, 84391M.
- [13] Salzenstein, P., Pavlyuchenko, E., Hmima, A., Cholley, N., Zarubin, M., Galliou, S., Chembo, Y. K., & Larger, L. (2012). Estimation of the uncertainty for a phase noise optoelectronic metrology system. *Physica Scripta* [T149], 014025, <http://dx.doi.org/10.1088/00318949/2012/T149/014025>.
- [14] GUM: (2008). Guide to the Expression of Uncertainty in Measurement, fundamental reference document. , JCGM 100: (GUM 1995 minor corrections) <http://www.bipm.org/en/publications/guides/gum.html> (accessed 5 June 2012).